



# APPROVAL SHEET

## Power supply

MODEL NO: SP-ATX-550Z-PPFC

ENGINEER NO: SUATX0200Z0ABPEU107



<b>Article No. :SP-AP-SU-A178</b> <b>Issue Date :2015-10-15</b> <b>Version : A/0</b>	<b>Audited by</b>
--	-------------------

<b>Checked by</b>	<b>Drafted by</b>
-------------------	-------------------

## Spire Corp.

Tel.: +86-755-26801565 Fax: +86-755-26801561

[Http://www.spire-corp.com](http://www.spire-corp.com)

[Http://www.spirepower.com](http://www.spirepower.com)

[Http://www.spirecoolers.com](http://www.spirecoolers.com)



**Approval Sheet Revisement Record**

**Article No:SP-AP-SU-A178**

<b>Version</b>	<b>Revised Chapter</b>	<b>Description</b>	<b>Revised Date</b>	<b>Drafted by</b>	<b>Audited by</b>	<b>ECN No.</b>
A/0	N/A	First Version				N/A



## Contents

<b>1</b>	<b>Introduction</b> .....	<b>5</b>
1.1	Scope.....	5
1.2	General Description.....	5
<b>2</b>	<b>Electrical</b> .....	<b>5</b>
2.1	AC Input.....	5
2.1.1	Input Over current Protection.....	5
2.1.2	Inrush Current Limiting.....	6
2.1.3	Withstand Voltage.....	6
2.1.4	Catastrophic Failure Protection.....	6
2.2	DC Output.....	6
2.2.1	DC Voltage Regulation.....	6
2.2.2	Output DC Current Ranges.....	7
2.2.3	Output Voltage Line Regulation. ....	7
2.2.4	Cross Regulation.....	7
2.2.5	Efficiency .....	7
2.2.6	Output Ripple/Noise.....	8
2.2.7	Output Transient Response.....	9
2.2.8	Capacitive Load .....	9
2.2.9	Closed-loop Stability .....	9
2.2.10	Power Sequencing.....	9
2.2.11	Voltage Hold-up Time.....	10
2.3	Timing / Housekeeping / Control.....	10
2.3.1	PWR_OK.....	10
2.3.2	PS_ON#.....	11
2.3.3	+5VSB.....	11
2.3.4	Power-on Time.....	11
2.3.5	Rise time.....	11



---

2.3.6	Overshoot at Turn-on /Turn-off.....	11
2.3.7	Reset after Shutdown.....	11
2.4	Output Protection.....	12
2.4.1	Over voltage Protection.....	12
2.4.2	Over Current Protection.....	12
2.4.3	Short-circuit Protection.....	12
<b>3</b>	<b>Mechanical.....</b>	<b>12</b>
3.1	AC Connector. ....	12
3.2	DC Connector Pin Description.....	13
<b>4</b>	<b>Environmental.....</b>	<b>14</b>
4.1	Environmental (Operating).....	14
4.2	Environmental (Non-Operating).....	14
<b>5</b>	<b>Electromagnetic Compatibility.....</b>	<b>14</b>
5.1	EMI.....	14
<b>6</b>	<b>Reliability.....</b>	<b>15</b>
6.1	Component Derating.....	15
6.2	Mean Time Between Failures(MTBF).....	15
<b>7</b>	<b>Correlative Certification compliance.....</b>	<b>15</b>
<b>8</b>	<b>Connectors&amp; cables diagram .....</b>	<b>16</b>
<b>9</b>	<b>Photograph .....</b>	<b>17</b>



## 1 Introduction

### 1.1 Scope

This specification defines the performance and characteristic for the model of SP-ATX-550Z-PPFC power supply.

### 1.2 General Description

SP-ATX-550Z-PPFC is a switching power supply, 550W self-contained, AC to DC power source supply suitable for mounting in PC.

- 1) SPCC 0.6MM ENCLOSURE
- 2) ONE 12CM FAN
- 3) Metal Case

## 2 Electrical

### 2.1 AC Input

Table 1 list AC input voltage and frequency requirements for continuous operation.

**Table 1. AC Input Line Requirements**

Parameter	Min.	Nom. <sup>(1)</sup>	Max.	Unit
Vin Voltage	200	220	240	VACrms
Vin Frequency	50	---	60	Hrzms

<sup>(1)</sup> Nominal voltages for test purposes are considered to be within  $\pm 1.0$  V of nominal.

Power Factor Correction (PFC)

SP-ATX-550Z-PPFC (w/ Passive PFC) is facilitated with the universal input 200~240VAC Passive PFC with the PF value  $\cong 0.65 \cong 0.8$

#### 2.1.1 Input Over Current Protection

The power supply is equipped with a non-reset-able fuse on the AC input to limit power consumption on a failure within the power supply module.

##### Input Fuse Rating:

Voltage	250 V
Current	6 A
De-activation time	200 ms



### **2.1.2 Inrush Current Limiting**

Maximum inrush current from power-on (with power on at any point on the AC sine) and including, but not limited to, three line cycles, shall be limited to a level below the surge rating of the input line cord, AC switch if present, bridge rectifier, fuse, and EMI filter components. Repetitive ON/OFF cycling of the AC input voltage should not damage the power supply or cause the input fuse to blow.

### **2.1.3 Withstand Voltage**

The power supply is capable of withstanding a maximum 1500 VDC potential between the input and ground for a period of 1 second.

### **2.1.4 Catastrophic Failure Protection**

If a component failure occurs, the power supply will not exhibit any of the following:

- 1) Flame
- 2) Excessive smoke
- 3) Charred PCB
- 4) Fused PCB conductor
- 5) Startling noise
- 6) Emission of molten material

## **2.2 DC Output**

### **2.2.1 DC Voltage Regulation**

The DC output voltages are remain within the regulation ranges shown in Table 2 when measured at the load end of the output connectors under all line, Load, and environmental conditions.

**Table 2. DC Input Line Requirements**

<b>Output</b>	<b>Range</b>	<b>Min.</b>	<b>Nom.(1)</b>	<b>Max.</b>	<b>Unit</b>
+12VDC	± 5%	+11.40	+12.00	+12.60	Volts
+5VDC	± 5%	+4.75	+5.00	+5.25	Volts
+3.3VDC	± 5%	+3.14	+3.30	+3.47	Volts
-12VDC	± 10%	-10.80	-12.00	-13.20	Volts
+5VSB	± 5%	+4.75	+5.00	+5.25	Volts

1) ATX +12VDC peak loading, regulation at the + 12Vdc output can go to±10%.

### 2.2.2 Output DC Current Ranges

All outputs are within the specified limits of regulation when each output is subjected to the conditions listed below.

**Table 3. DC Input Line Requirements**

DC Nominal Voltage	Minimum Current	Maximum Current
+12 V DC	1.2 A	25A
+5 V DC	2.4 A	30A
+3.3 V DC	0.1 A	28A
- 12 V DC	0.0 A	0.8A
+5 V SB	0.1 A	2.0A

NOTE:

- 1)The combined power output of +5V and +3.3V shall not exceed248W.  
The combined power output of +5V,+3.3V and +12V shall not exceed 525W
- 2)When +12V,+5V loading max load ,total output power can be 550W whose lasting time shall not exceed 15 seconds .The voltage regulation range of any output loading surge load shall be +/-10%.
- 3)Input voltage is 220-240Vac ,When peak load.

### 2.2.3 Output Voltage Line Regulation

The following table specifies line regulation as measured from minimum to maximum load including the transient response requirements as detailed in this document.

**Table 4. DC Output Tolerance Specifications**

DC Nominal Output	Output Voltage Tolerance
+12V DC	±1%
+5V DC	±1%
+3.3V DC	±1%
-12V DC	±2%
+5V SB	±1%

### 2.2.4 Cross Regulation

The power supply DC outputs perform within all line and load specifications Regardless of the static or transient loads on any of the outputs.

### 2.2.5 Efficiency

68% minimum at 230VAC, 550W output.

### 2.2.6 Output Ripple/Noise

The output ripple/noise requirements listed in Table 5 should be met throughout the load ranges specified and under all input voltage conditions as specified. Ripple and noise are defined as periodic or random signals over a frequency band of 10 Hz to 20MHz. Measurements shall be made with an oscilloscope with 20 MHz bandwidth. Outputs should be bypassed at the connector with a 0.1µF ceramic disk capacitor and a 10µF electrolytic capacitor to simulate system loading. See Figure1.

**Table 5. DC Output Ripple/Noise**

Output	Max. Ripple (mVpp)	Max. Ripple& Noise (mVpp)
+12 VDC	120	240
+5 VDC	50	100
+3.3 VDC	50	100
-12 VDC	120	240
+5 VSB	50	100

**Figure1. Differential Noise Test Setup**

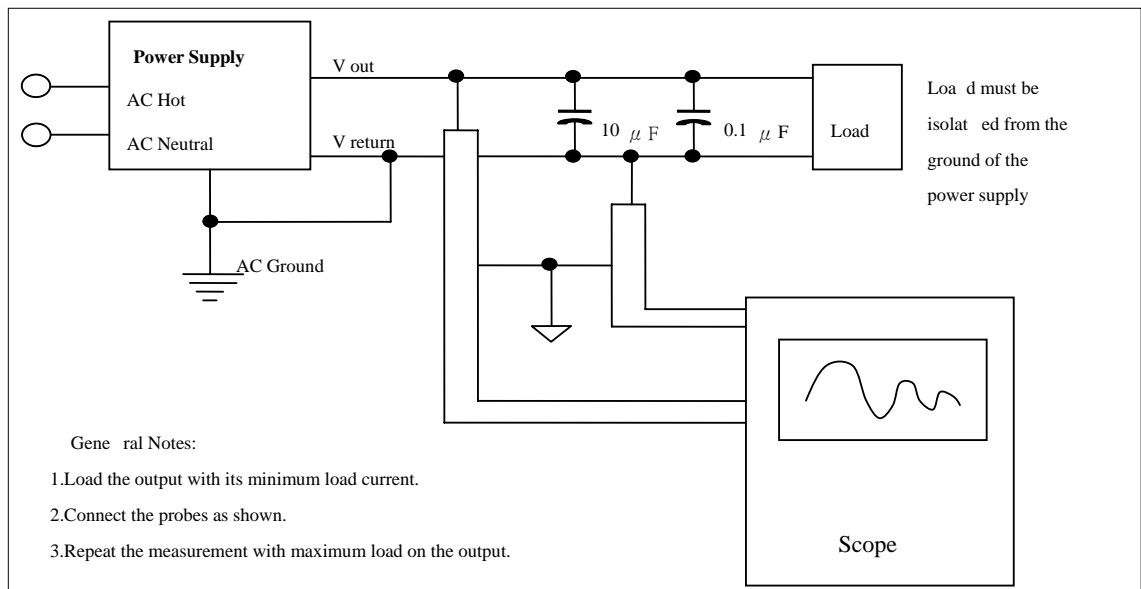



### 2.2.7 Output Transient Response

The table below summarizes the output transient steps for each output. The Transient slew rate is  $\approx 0.5A/\mu s$ .

**Table 6. DC Output Transient Response Specifications**

DC Output	Maximum Step Size	Output Voltage Tolerance
+12VDC	50% of rated output	$\pm 5\%$
+5VDC	50% of rated output	$\pm 5\%$
+3.3VDC	30% of rated output	$\pm 5\%$
-12VDC	0.1A	$\pm 10\%$
+5VSB	0.1A	$\pm 5\%$

### 2.2.8 Capacitive Load

The power supply is able to power up and operate normally with the following capacitances simultaneously present on the DC outputs.

**Table 7. Output Capacitive Loads**

DC Output	ATX12V Capacitive Load ( $\mu F$ )
+12 VDC	20,000
+5 VDC	10,000
+3.3 VDC	6,000
-12 VDC	350
+5 VSB	350

### 2.2.9 Closed-loop Stability

The power supply is unconditionally stable under all line/load/transient loads Conditions including capacitive loads specified in Table 7. A minimum of 45 degrees phase margin and 10 dB gain margin is recommended at both the maximum and minimum loads.

### 2.2.10 Power Sequencing

All outputs, regardless of loading, turn on within 50ms of each other. The 5VSB output is in regulation for a minimum of 10ms prior to the other output rails reaching regulation.

### 2.2.11 Voltage Hold-up Time

All output will stay within regulation for at least 16ms after an AC line voltage failure is detected at nominal line (230VAC) under full load condition.

### 2.3 Timing / Housekeeping / Control

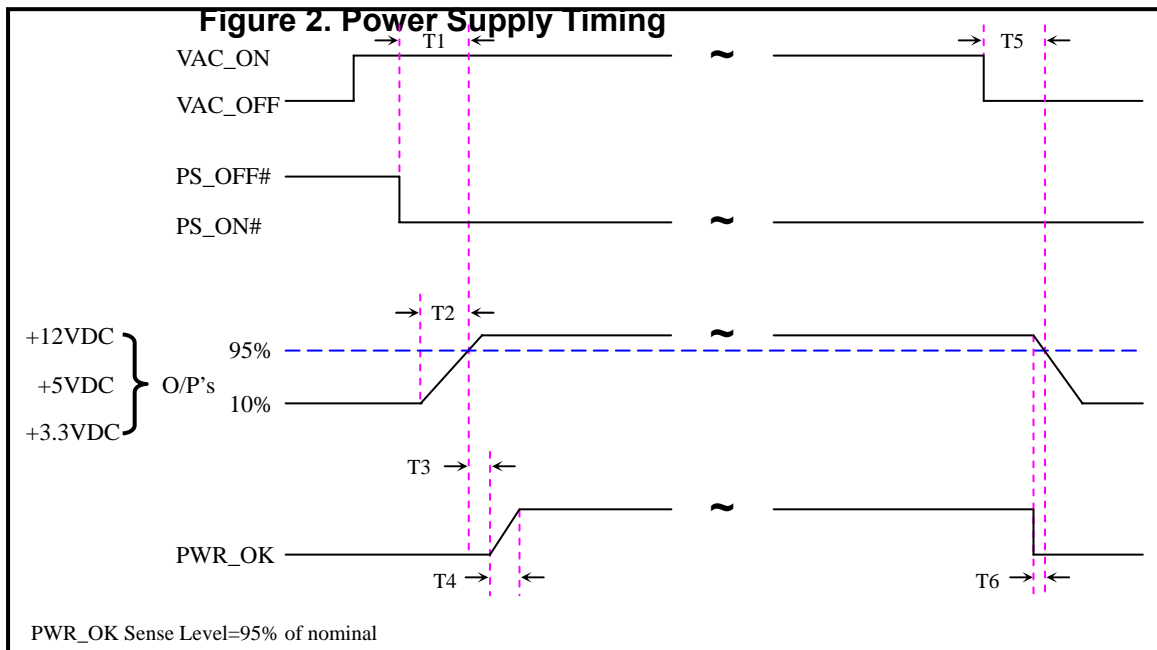

$T1 < 100\text{ms}$
$0.1\text{ms} \leq T2 \leq 25\text{ms}$
$100\text{ms} < T3 < 500\text{ms}$
$T4 \leq 10\text{ms}$
$T5 \geq 16\text{ms}$
$T6 \geq 1\text{ms}$

T1 : Power-on Time
T2 : Rise Time
T3 : PWR_OK Delay
T4 : PWR_OK Risetime
T5 : AC Loss to PWR_OK Hold-up Time
T6 : Power-down Warning

#### 2.3.1 PWR\_OK

The power supply accepts a logic collector level which will disable/enable all the output voltages. As the logic level is low, output voltages are enable; As the logic level is high, output voltages are disable. The definition of logic low/high level is as:

High Level: 2.50V ~ 5.25V while sourcing 0.4mA maximum

Low Level: 0.0V ~ 0.50V while sinking 5.0mA maximum

Rise Time: 3.0ms maximum (10.0% ~ 90.0%)

### 2.3.2 PS\_ON#

The power supply provides an internal pull-up to TTL high. The power supply also provides denounce circuitry on PS\_ON# to prevent it from oscillating on/off at startup when activated by a mechanical switch. The DC output enable circuitry is SELV-complaint.

**Table 8. PS\_ON# Signal Characteristics**

	<b>Min.</b>	<b>Max.</b>
V <sub>IL</sub> , Input Low Voltage	0.0V	0.8V
V <sub>IL</sub> , Input Low Current (V <sub>in</sub> = 0.4 V)		-1.6mA
V <sub>IH</sub> , Input High Voltage (I <sub>in</sub> = -200 $\mu$ A)	2.0V	
V <sub>IH</sub> , open circuit, I <sub>in</sub> = 0		5.25V

### 2.3.3 +5VSB

The +5VSB is capable of delivering a maximum of 2.5A at +5V  $\pm$ 5% to external circuit. The power supply +5VSB is with overcurrent protection.

### 2.3.4 Power-on Time

The power-on time is less than 100ms (T<sub>1</sub> < 100ms). The +5VSB has a power-on time of two seconds maximum after application of valid AC voltages. (Figure 1)

### 2.3.5 Rise time

The output voltages rise from  $\leq$  10% of nominal to within the regulation ranges within 0.1ms to 25ms (0.1ms  $\leq$  T<sub>2</sub>  $\leq$  25ms). (Figure 2)

### 2.3.6 Overshoot at Turn-on / Turn-off

Any overshoot at turn on or turn off is under 10% of the nominal DC output voltage with further stipulation that all DC outputs are within their specified DC voltage ranges before the generation of the power good signal. Additionally, no voltage may undershoot or overshoot once the power good signal has been asserted.

### 2.3.7 Reset after Shutdown

The power supply latches into a shutdown state because of a fault condition on its outputs, the power supply returns to normal operating after the fault has been removed and the PS\_ON# (or AC input) has been cycled OFF/ON with a minimum OFF time of 1 second.



## **2.4 Output Protection**

Each DC output is protected from over voltage, over current and short circuit. The following sections include the details for these protection mechanisms.

### **2.4.1 Over voltage Protection**

The overvoltage sense circuitry and reference reside in packages that are separate and distinct from the regulator control circuitry and reference. No single point fault is able to cause a sustained overvoltage condition on any or all outputs. The power supply provides latch-mode overvoltage protection defined as:

+5V output is between 5.74V to 7V

+12V output is between 13.4V to 15.6V

+3.3V output is between 3.76V to 4.8V

### **2.4.2 Over Current Protection**

The power supply DC outputs are protected from supplying output current above the maximum ratings defined in Table 3, and when output power is between 120%~180%. With the exception of the 5VSB output, all DC outputs are latched off in the event of an over-current event on any of the DC outputs. In the event of a short circuit on any output, except the 5VSB rail, all outputs are disabled and remain disabled until the power supply is powered off back on. The 5VSB rail will recover upon removal of the over current condition.

### **2.4.3 Short-circuit Protection**

The power supply DC outputs are protected from damage due to faults, when any output shorts to ground. In the event of a short circuit on any output, all outputs shall be disabled and remain disabled until the power supply is powered off and back on. The +5VSB rail will recover upon removal of the over current condition.

## **3 Mechanical**

### **3.1 AC Connector**

The AC input receptacle is an IEC 320 type or equivalent. In lieu of a dedicated switch, the IEC 320 receptacle may be considered the mains disconnect.

### 3.2 DC Connector Pin Description

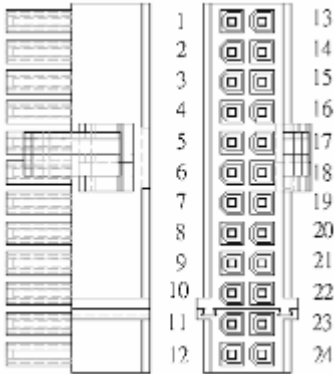

Pin	Color	Signal	Pin	Color	Signal
1	Orange	+3.3VDC	13	Orange Brown	+3.3VDC +3.3V default sense
2	Orange	+3.3VDC	14	Blue	-12VDC
3	Black	COM	15	Black	COM
4	Red	+5VDC	16	Green	PS_ON/OFF
5	Black	COM	17	Black	COM
6	Red	+5VDC	18	Black	COM
7	Black	COM	19	Black	COM
8	Gray	PWR_OK	20	NG	NG
9	Purple	+5VSB	21	Red	+5VDC
10	Yellow	+12VDC	22	Red	+5VDC
11	Yellow	+12VDC	23	Red	+5VDC
12	Orange	+3.3VDC	24	Black	COM

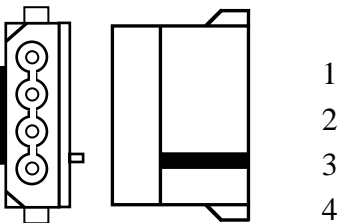

Pin	Color	Signal	Pin	Color	Signal
1	Red	+5VDC	3	Black	COM
2	Black	COM	4	Yellow	+12VDC

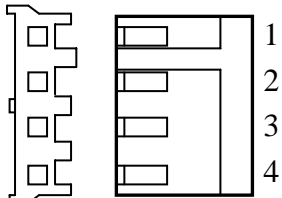

Pin	Color	Signal	Pin	Color	Signal
1	Red	+5VDC	3	Black	COM
2	Black	COM	4	Yellow	+12VDC

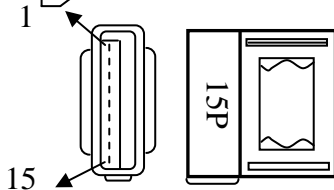

Pin	Color	Signal	Pin	Color	Signal
1-3	Orange	+3.3VDC	10-12	Black	GND
4-6	Black	GND	13-15	Yellow	+12VDC
7-9	Red	+5VDC			

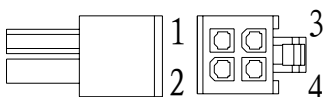

Pin	Color	Signal	Pin	Pin	Signal
1	Black	COM	3	Yellow	+12VDC
2	Black	COM	4	Yellow	+12VDC



## **4 Environmental**

### **4.1 Environmental (Operating)**

Temperature: 0°C to 40°C

Humidity: 5% to 90% Relative Humidity (non condensing)

Altitude: 0 meters to +3,048 meters

### **4.2 Environmental (Non-Operating)**

Temperature: -20°C to 60°C

Humidity: 5% to 85% Relative Humidity (non condensing)

Altitude: 0 meters to +15,244 meters

## **5 Electromagnetic Compatibility**

The following subsections outline sample product regulations requirements for a typical Power supply. Actual requirements will depend on the design, product end use, target Geography, and other variables. Consult your company's Product Safety and Regulations Department for more details

### **5.1 EMI**

The power supply is complied with CISPR 22, Class B. Tests are performed at 220VAC 50 Hz power. The SP-ATX-550W-PFC meets the requirement of EN 61000-3-2 Class D, and EN 61000-3-3, and the Guidelines for the Suppression of Harmonics in Appliances and General Use Equipment Class D for harmonic line current content at full-rated power.



## 6 Reliability

### 6.1 Component Derating

The following component derating guidelines are recommended:

- Semiconductor junction temperatures shall not exceed 110°C with an ambient of 50°C.
- Inductor case temperature shall not exceed safety agency requirements.
- Capacitor case temperature shall not exceed 95% of rated temperature.
- Component voltage and current derating shall be >10% at 50°C.
- Magnetic saturation of any transformer will not be allowed under any line, load, startup or transient condition including 100% transients on the five main outputs or +5VSB.

### 6.2 Mean Time Between Failures(MTBF)

The power supply reliability is based on the calculation with the Part-Stress Analysis method of MIL-HDBK-217F using the quality factors listed in MIL-HDBK-217F. The power supply MTBF is 100,000 hours under the following conditions:

- Full-rated load
- 230VAC input
- Ground begin
- 25°C ambient

## 7. Correlative Certification compliance

Item #	Certification type	Certification Number	Certification listing	Remark
1	CE/EMC	TMC20110425EC01	WWW.TMC-LAB.C OM	
2	CE/LVD	TMC20110425SC01	WWW.TMC-LAB.C OM	

8.Connectors and cables diagram :

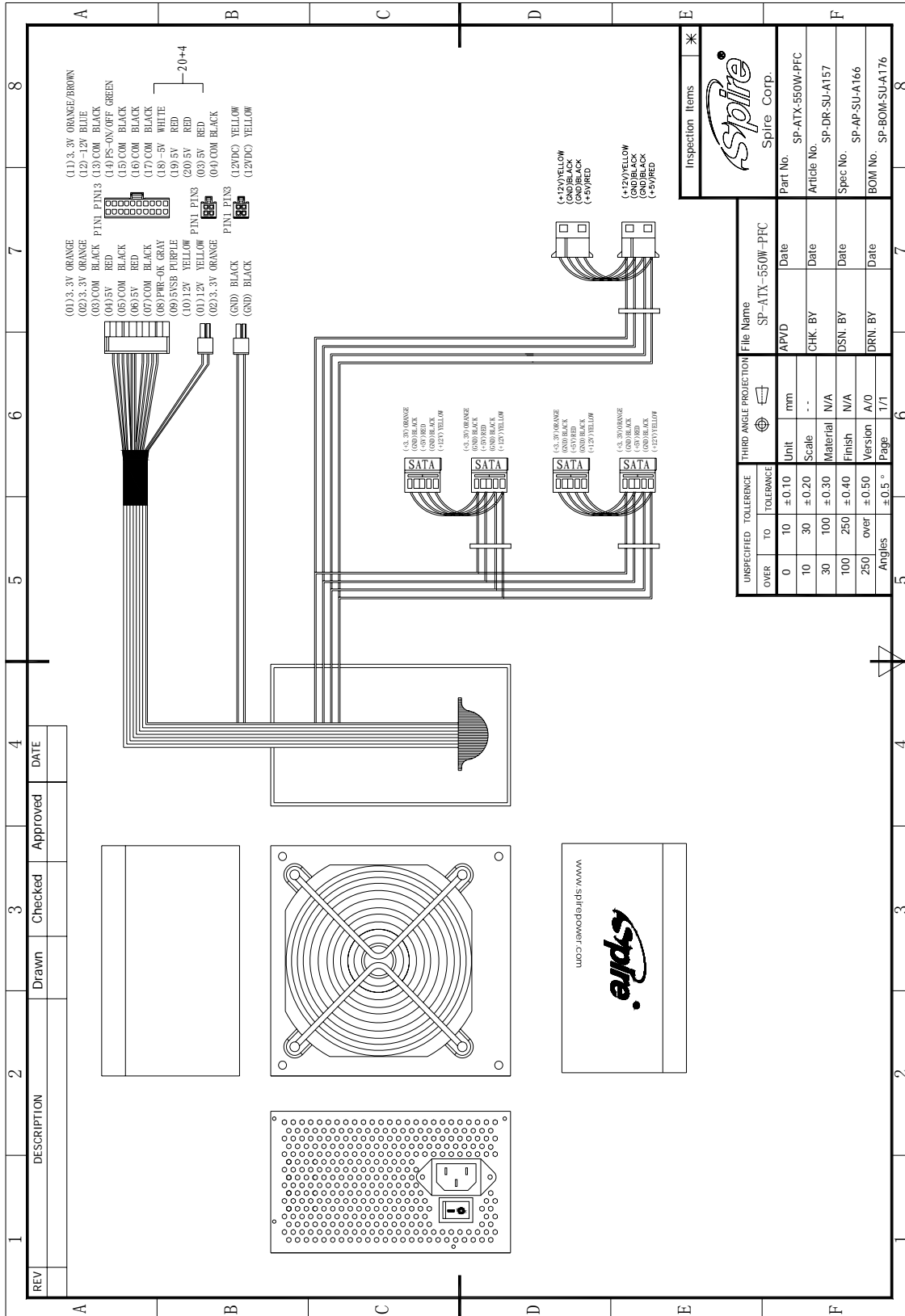



### 9. Photograph:

